

V

V7P/V10P
Manual 1.3 en

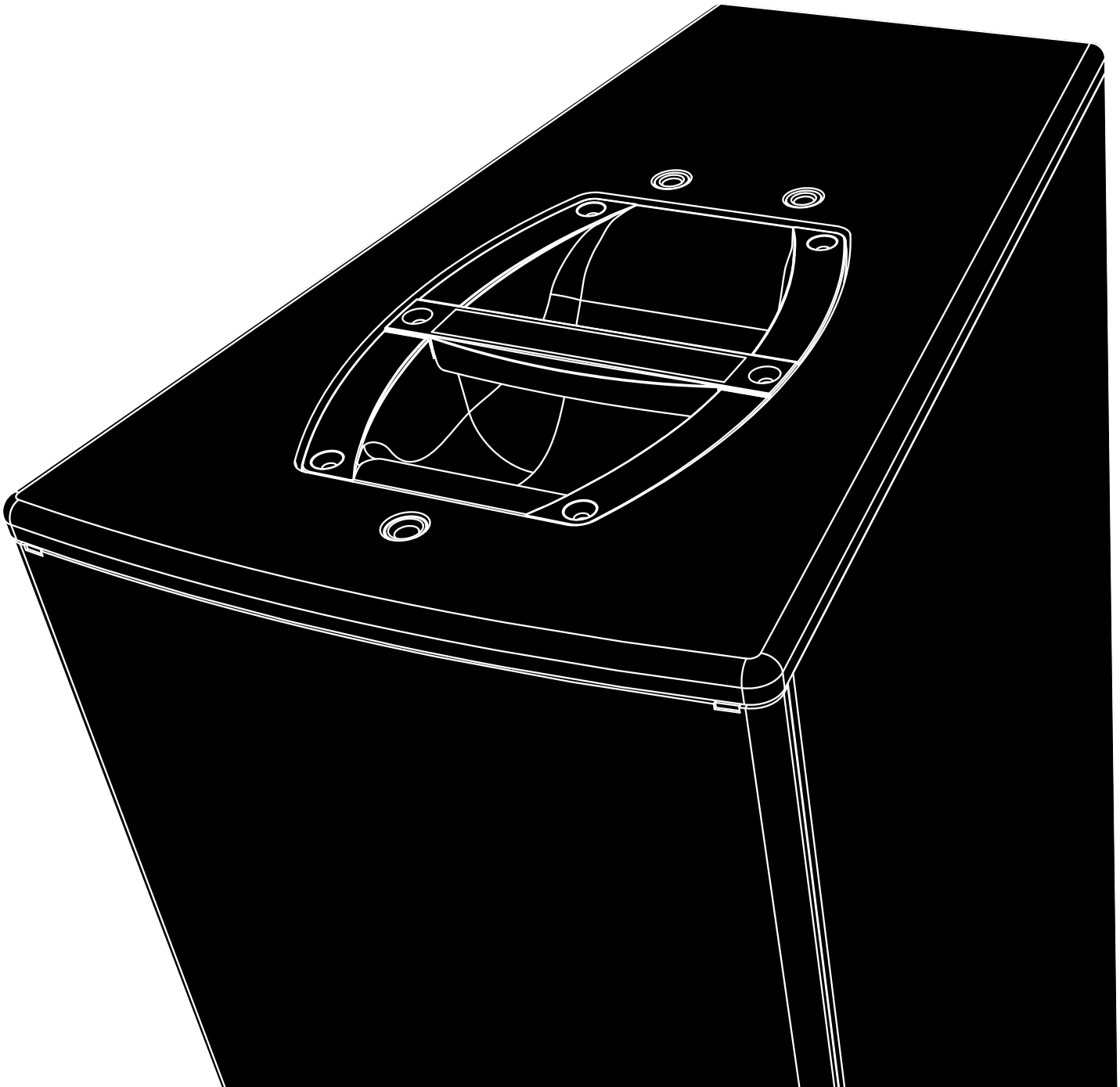

General information

V7P/V10P Manual

Version: 1.3 en, 10/2016, D2722.EN .01

Copyright © 2016 by d&b audiotechnik GmbH; all rights reserved.

Keep this manual with the product or in a safe place so that it is available for future reference.

When reselling this product, hand over this manual to the new owner.

If you supply d&b products, please draw the attention of your customers to this manual. Enclose the relevant manuals with the systems. If you require additional manuals for this purpose, you can order them from d&b.

d&b audiotechnik GmbH
Eugen-Adolff-Strasse 134, D-71522 Backnang, Germany
T +49-7191-9669-0, F +49-7191-95 00 00
docadmin@dbaudio.com, www.dbaudio.com

1. Safety precautions	4
1.1. Information regarding the use of loudspeakers.....	4
2. V7P/V10P loudspeaker	5
2.1. Product description.....	5
2.2. Connections.....	6
2.3. Operation.....	6
2.3.1. Controller settings.....	6
2.4. Dispersion characteristics.....	8
2.5. Technical specifications.....	11
3. Manufacturer's declarations	13
3.1. EU conformity of loudspeakers (CE symbol).....	13
3.1.1. WEEE Declaration (Disposal).....	13

1.1. Information regarding the use of loudspeakers

Potential risk of personal injury

Never stand in the immediate vicinity of loudspeakers driven at a high level. Professional loudspeaker systems are capable of causing a sound pressure level detrimental to human health. Seemingly non-critical sound levels (from approx. 95 dB SPL) can cause hearing damage if people are exposed to it over a long period.

In order to prevent accidents when deploying loudspeakers on the ground or when flown, please take note of the following:

- When setting up the loudspeakers or loudspeaker stands, make sure they are standing on a firm surface. If you place several systems on top of one another, use straps to secure them against movement.
- Only use accessories which have been tested and approved by d&b for assembly and mobile deployment. Pay attention to the correct application and maximum load capacity of the accessories as detailed in our specific "Mounting instructions" or in our "Flying system and Rigging manuals".
- Ensure that all additional hardware, fixings and fasteners used for installation or mobile deployment are of an appropriate size and load safety factor. Pay attention to the manufacturers' instructions and to the relevant safety guidelines.
- Regularly check the loudspeaker housings and accessories for visible signs of wear and tear, and replace them when necessary.
- Regularly check all load bearing bolts in the mounting devices.

Potential risk of material damage

Loudspeakers produce a static magnetic field even if they are not connected or are not in use. Therefore make sure when erecting and transporting loudspeakers that they are nowhere near equipment and objects which may be impaired or damaged by an external magnetic field. Generally speaking, a distance of 0.5 m (1.5 ft) from magnetic data carriers (floppy disks, audio and video tapes, bank cards, etc.) is sufficient; a distance of more than 1 m (3 ft) may be necessary with computer and video monitors.

2. V7P/V10P loudspeaker

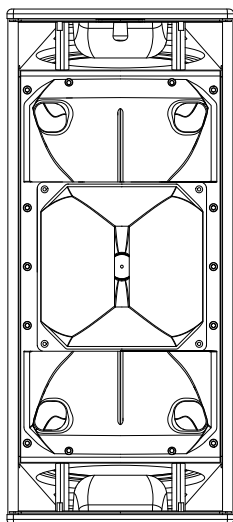

V7P loudspeaker

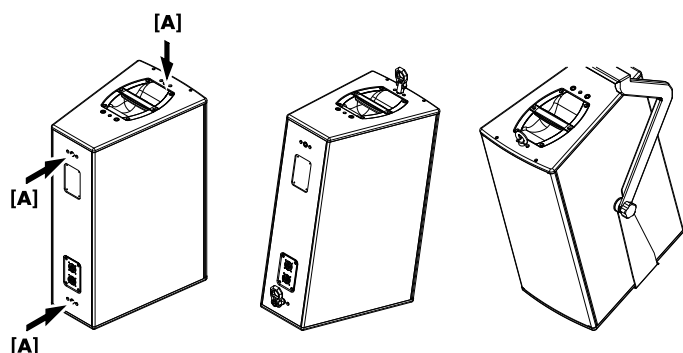

2.1. Product description

V7P/V10P are passive 3-way loudspeakers housing two 10" LF drivers, one horn-loaded 8" MF driver and a 1.4" HF compression driver with a rotatable CD horn producing a nominal dispersion (h x v) of 75° x 40° (V7P) and 110° x 40° (V10P), respectively.

All components are arranged symmetrically around the center axis of the cabinet to produce a perfect symmetrical dispersion pattern. This setup allows for a crossover design with a well defined overlap of adjacent frequency bands resulting in a very consistent and accurate vertical dispersion. Due to the dipolar arrangement of the low drivers, broadband vertical dispersion control is maintained down to approximately 350 Hz – an outstanding feature for a passive 3-way system.

The frequency response extends from 59 Hz to above 18 kHz.

The cabinets are constructed from marine plywood and have an impact and weather protected PCP (Polyurea Cabinet Protection) finish. The top and bottom panels incorporate a handle each. The front of the loudspeaker cabinet is protected by a rigid metal grill backed by an acoustically transparent foam.

The cabinets are fitted with three types of rigging devices:

- Two M10 threaded inserts on the top and bottom panels each to accept either the Z5383 VP Mounting bracket, the Z5384 VP Flying adapter or the Z5388 VP Horizontal bracket.
- Three additional combined sockets [A], one in the top panel and two at the rear of the cabinet that accept either:
 - the Q9032 Safety eye bolt M10 to apply a independent secondary safety device.
 - the Z5049 Flying pin 8 mm to support single cabinets or to secure the aiming of an array.

Intended use of the Z5049 Flying pin



WARNING!

Potential risk of personal injury and/or damage to material!

The Z5049 Flying pin 8 mm is designed and intended for static loads only. Therefore please observe the following:

- The Flying pin must not be used to attach a secondary safety device.
- Ensure the Flying pin is securely locked before lifting any load.

Proceed as follows:

1. Press the button to release the locking mechanism ([r] →).
2. Fully insert the Flying pin into the respective socket.
3. Release the button to lock the pin ([l] ←).
4. Recheck the Flying pin is securely locked by briefly pulling the Flying pin towards you.

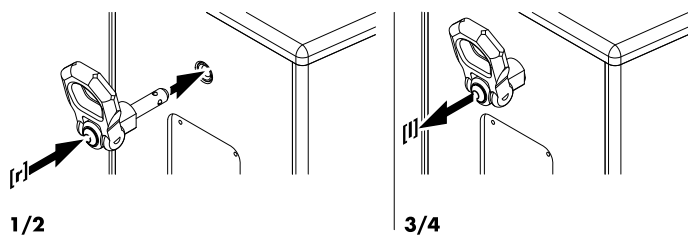

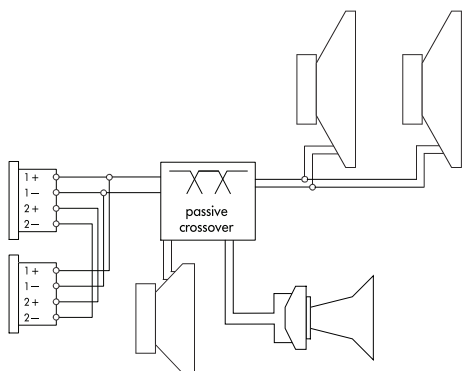

Connector wiring

2.2. Connections

The cabinets are fitted with NLT4 F/M connectors. All four pins of both connectors are wired in parallel. The cabinet uses the pin assignments 1+/1-. Pins 2+/2- are designated to actively driven subwoofers. Using one connector as the input, the second connector allows for direct connection to a second cabinet.

The cabinets can be supplied with NL4 M or EP5 connectors as an option.

Pin equivalents of the connector options are listed in the table below.

NLT4 F/M NL4 M	1+	1-	2+	2-	n.a.
EP5	1	2	3	4	5

d&b LoadMatch

Starting with the D80 amplifier platform, the LoadMatch function enables the amplifier to electrically compensate for the properties of the loudspeaker cable used without the need for an additional sense wire. For applicable loudspeakers, LoadMatch is therefore independent of the connector type used.

2.3. Operation

NOTICE!

Only operate d&b loudspeakers with a correctly configured d&b amplifier, otherwise there is a risk of damaging the loudspeaker components.

Applicable d&b amplifiers:

D80/D20/D12/30D.

Application	Setup	Cabinets per channel
V7P	V7P	2
V10P	V10P	2

For applicable d&b amplifiers, the controller setups are available in Dual Channel and/or Mix TOP/SUB mode. For combinations with active subwoofers fed by a single 4-wire cable Mix TOP/SUB mode must be selected.

2.3.1. Controller settings

For acoustic adjustment the functions CUT, HFA and CPL can be selected.

CUT mode

Set to CUT, the low frequency level is reduced. The cabinets are now configured for use with actively driven d&b subwoofers.

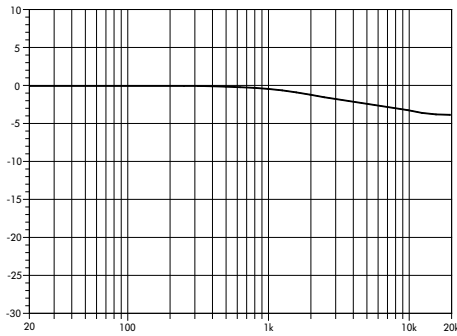

Frequency response correction in HFA mode

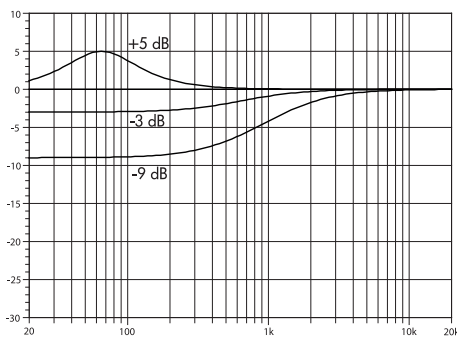

Frequency response correction of the CPL function

HFA mode

In HFA mode (High Frequency Attenuation), the HF response of the system is rolled off. HFA provides a natural, balanced frequency response when a cabinet is placed close to listeners in near field or delay use.

High Frequency Attenuation begins gradually at 1 kHz, dropping by approximately 3 dB at 10 kHz. This roll off mimics the decline in frequency response experienced when listening to a system from a distance in a typically reverberant room or auditorium.

CPL function

The CPL (Coupling) function compensates for coupling effects between the cabinet and close boundary surfaces. CPL begins gradually around 1 kHz, with the maximum attenuation below 400 Hz. To achieve a balanced frequency response, the CPL function can be set to dB attenuation values between 0 and -9.

Positive CPL values create an adjustable low frequency boost (0 to +5 dB) at around 65 Hz and can be set when the system is used in full range mode without subwoofers.

2.4. Dispersion characteristics

The following graphs show dispersion angle over frequency of a single cabinet plotted using lines of equal sound pressure (isobars) at -6 dB and -12 dB.

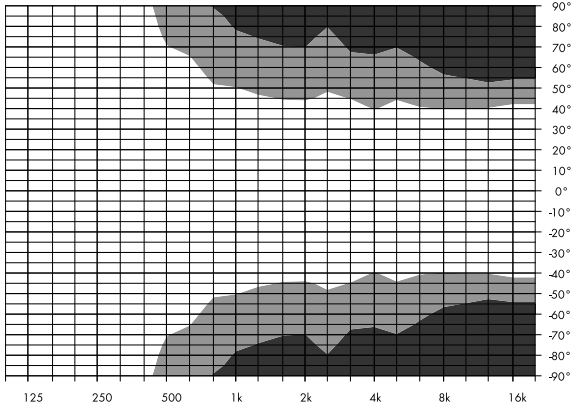

Isobar diagram horizontal

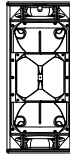

V7P
vertical setup

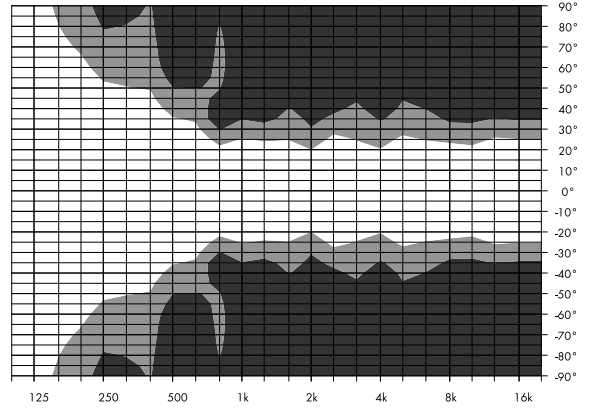

Isobar diagram vertical

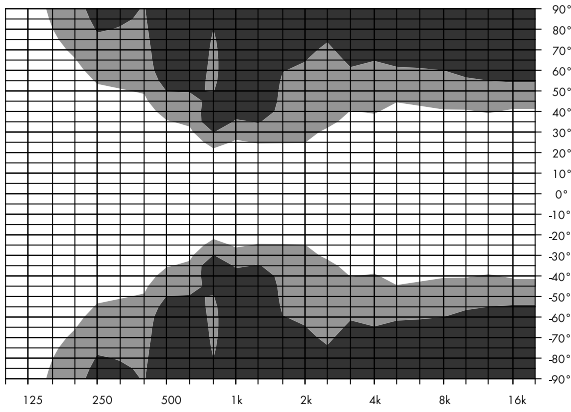

Isobar diagram horizontal

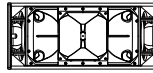

V7P
horizontal setup,
horn rotated

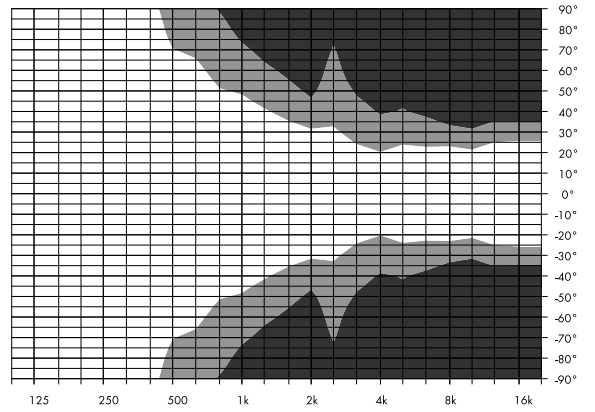

Isobar diagram vertical

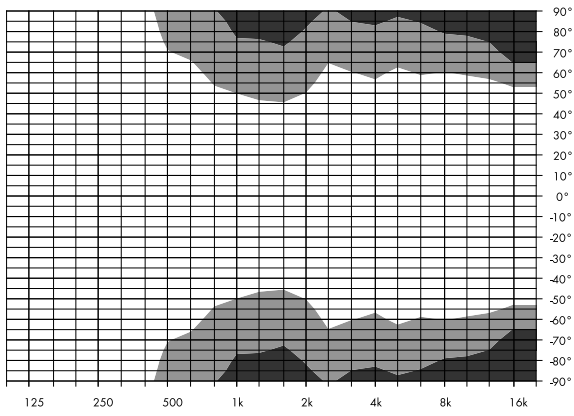

Isobar diagram horizontal

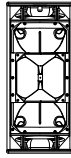

V10P

vertical setup

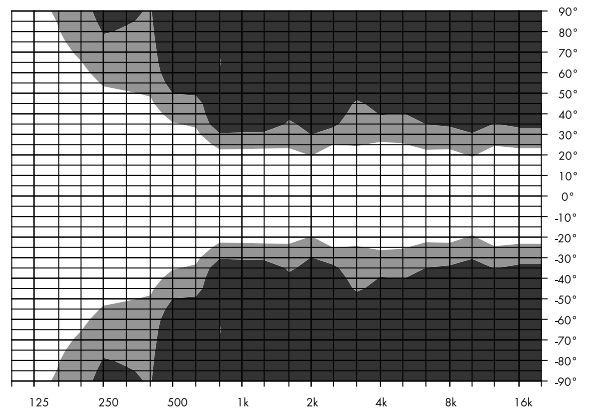

Isobar diagram vertical

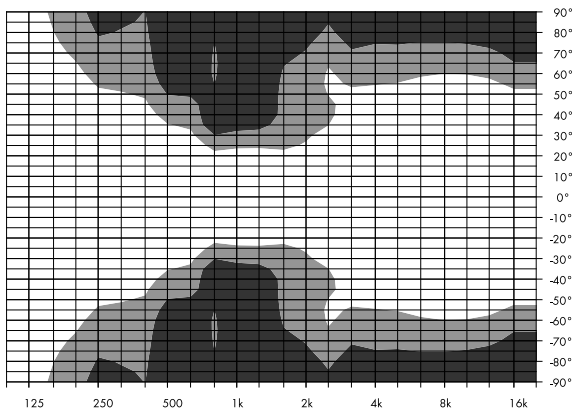

Isobar diagram horizontal



V10P

horizontal setup,
horn rotated

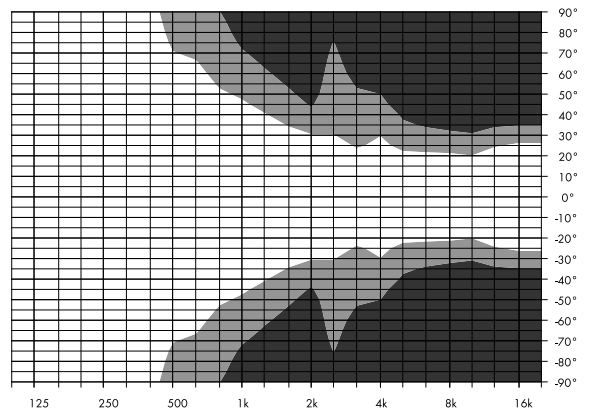

Isobar diagram vertical

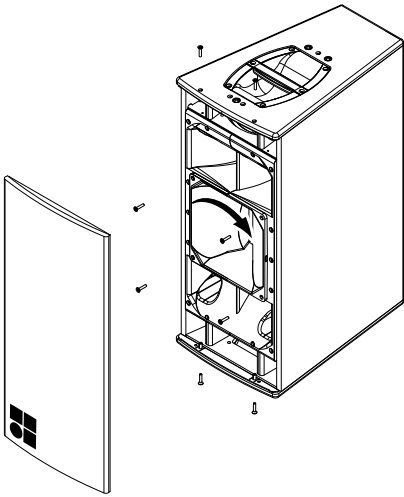
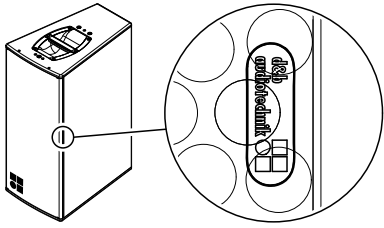

Altering the HF dispersion

Altering the HF horn dispersion

By factory default, the HF horn is fitted to the cabinet providing the nominal horizontal dispersion when the cabinet is used in upright position. This is indicated by a white label on the horn flange. The label is visible through the front grill on each side of the cabinet as shown in the graphic opposite.

The HF horn can be rotated through 90°.

Tools required: Torx wrench (#TX20).

1. Undo the torx screws on the top and bottom panels of the cabinet and remove the front grill.
2. Undo the screws holding the horn flange and rotate the horn.
3. Refit the horn as follows:
 - Make sure the gasket of the horn is in place.
 - Refit the horn.
 - Insert all screws and carefully tighten them clockwise until they fit precisely into the countersunk holes.
4. Refit the front grill.

2.5. Technical specifications

V7P/V10P system data

Frequency response (-5 dB standard)	59 Hz - 18 kHz
Frequency response (-5 dB CUT mode)	100 Hz - 18 kHz
Max. sound pressure (1 m, free field)	
V7P with D12/D20/30D	137 dB
V7P with D80	140 dB
V10P with D12/D20/30D	136 dB
V10P with D80	139 dB
	(SPLmax peak, pink noise test signal with crest factor of 4)

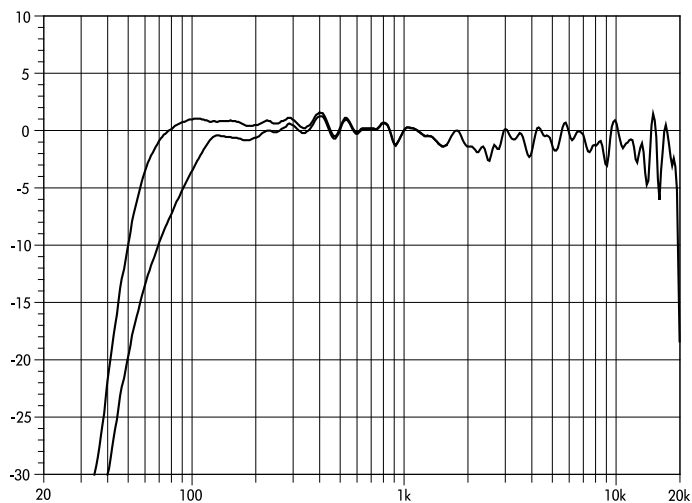

V7P frequency response, standard and CUT modes

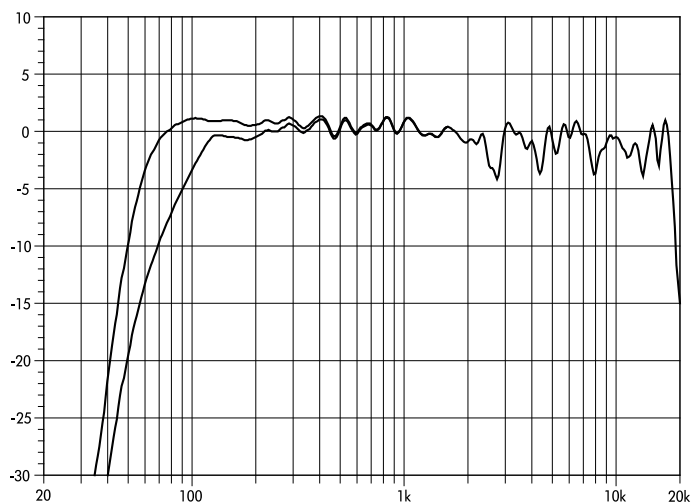

V10P frequency response, standard and CUT modes

V7P/V10P loudspeaker

Nominal impedance	8 ohms
Power handling capacity (RMS/peak 10 ms)	500/2000 W
Nominal dispersion angle (horizontal) V7P	75°
Nominal dispersion angle (horizontal) V10P	110°
Nominal dispersion angle (vertical)	40°
Components	2 x 10" LF driver with neodymium magnet
	1 x 8" MF driver with neodymium magnet
	1.4" exit compression driver
	Passive crossover network
Connections	2 x NLT4 F/M
	optional 2 x NL4 M or 2 x EP5
Pin assignment	NLT4 F/M and NL4 M: 1+/1-
	EP5: 1: + / 2: -
Weight	33 kg (75 lb)

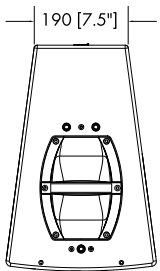
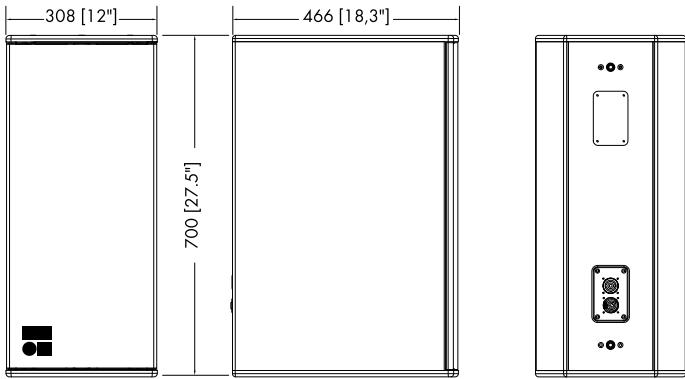

V7P/V10P cabinet dimensions in mm [inch]



3.1. EU conformity of loudspeakers (CE symbol)

This declaration applies to:

d&b V7P loudspeaker, Z0704

d&b V10P loudspeaker, Z0705

manufactured by d&b audiotechnik GmbH.

All production versions of these types are included, provided they correspond to the original technical version and have not been subject to any later design or electromechanical modifications.

We herewith declare that said products are in conformity with the provisions of the respective EC directives including all applicable amendments.

A detailed declaration is available on request and can be ordered from d&b or downloaded from the d&b website at www.dbaudio.com.

3.1.1. WEEE Declaration (Disposal)

Electrical and electronic equipment must be disposed of separately from normal waste at the end of its operational lifetime.

Please dispose of this product according to the respective national regulations or contractual agreements. If there are any further questions concerning the disposal of this product, please contact d&b audiotechnik.

